

# SHARP

# MX-M754N MX-M654N

Digital Multifunction System

Meet All Your Document Needs  
with One Flexible and Productive Solution



COPY

NETWORK PRINT

NETWORK  
COLOUR SCAN

FAX  
OPTION

# Designed to Streamline Business with Outstanding Performance and Easy Expandability

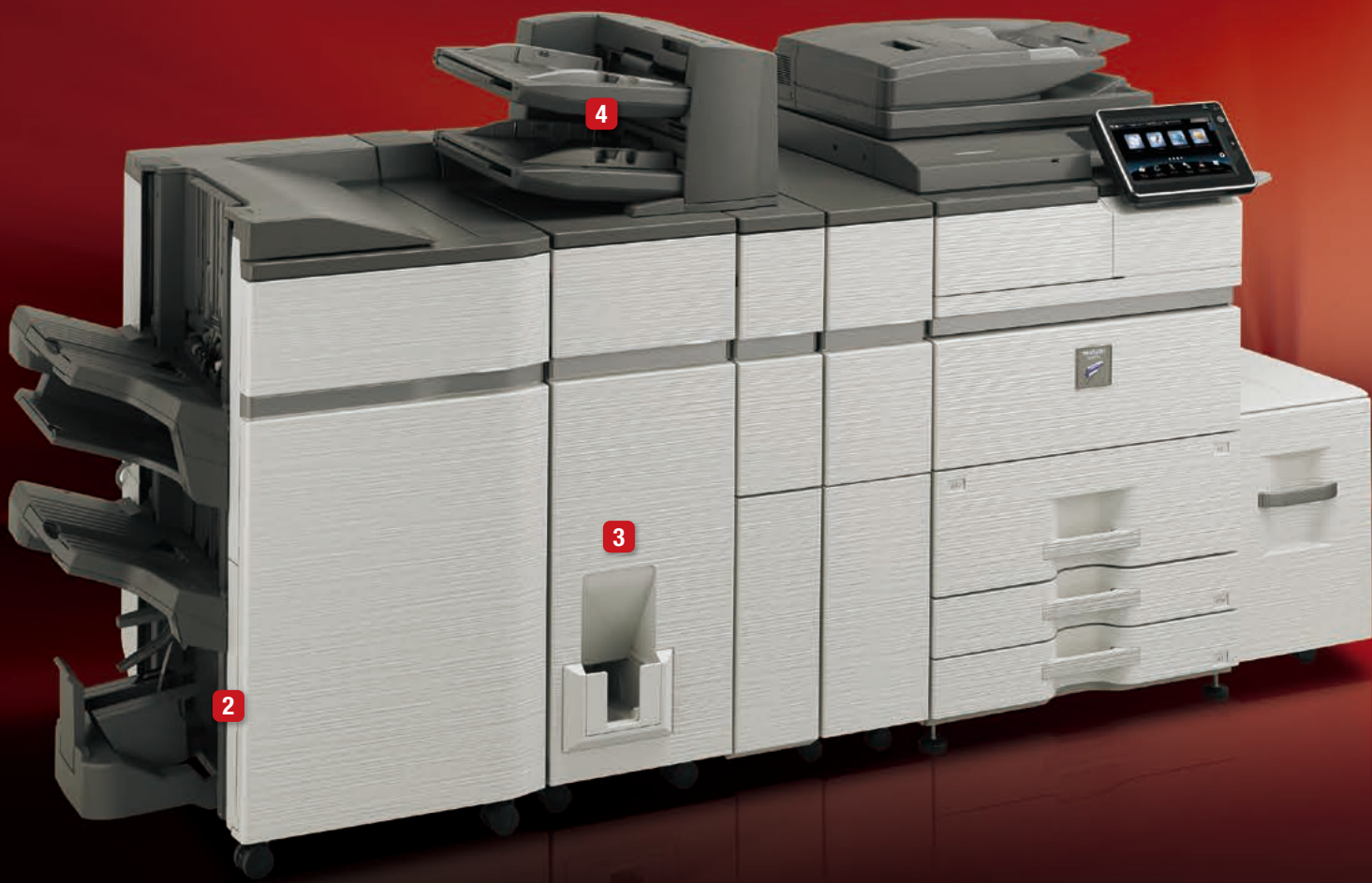

## PRODUCTIVITY

### 1 Finishers

With a maximum output capacity of 4,250 sheets, handy finishers provide three stapling positions—front corner, rear corner, and two-point side—for up to 50 sheets

(MX-FN19/FN20) or 100 sheets (MX-FN21/FN22) per set. Two-to-four-hole punching is available as an option.



### 2 Saddle Stitch Finishers

In addition to conventional stapling, the MX-FN20/FN22 Saddle Stitch Finishers can staple and fold sets of documents—up to 15 sheets for MX-FN20 and up to 20 sheets for MX-FN22—to make professional-looking booklets.



### 3 Folding Unit

The MX-FD10 Folding Unit automates five types of folding—z-fold, c-fold, accordion fold, double fold, and half-fold for efficient production of direct mail, brochures, and more.



The high-performing MX-M754N/M654N boasts everything needed to bring exceptional document workflow, brilliant image quality, and intuitive ease of use to even the busiest workplace. Built for reliable, energy-efficient operation, this versatile solution also offers meet-your-needs expandability. In fact, the MX-M754N/M654N partners easily with a range of convenient finishing and feature options in flexible document system configurations that can boost efficiency and grow in sync with your business. There's simply no better solution for streamlining business.



1

5

#### 4 Inserter

For truly professional results, the MX-CF11 Inserter can add pre-printed covers and insert paper up to 220 g/m<sup>2</sup> to documents before final finishing. Two input trays, each with a capacity of 200 sheets, make it possible to feed in two different types of paper.

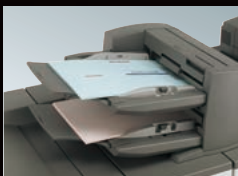

#### USABILITY

#### 5 10.1-Inch Colour LCD Touchscreen

A user-friendly touchscreen interface enables intuitive MFP operation. Document finishes and page layout can be confirmed onscreen before printing out to prevent erroneous printouts and paper waste. And documents can be previewed in various modes to match the task at hand.



#### ECO FRIENDLINESS

#### Energy Efficiency

Conforming to the ENERGY STAR<sup>®</sup> programme, an international system identifying energy-efficient products, the MX-M754N/M654N boasts state-of-the-art environmental technologies and a range of eco functions. A short warm-up time is just one of the pluses making this MFP a real energy saver.



## Super-Efficient Output



The MX-M754N/M654N delivers a fast output of **75/65 ppm\***.

The first copy comes out in just **3.5/3.9**

**seconds** to save valuable time when performing multiple short-run jobs.

\*A4 (8 1/2" x 11"), long-edge feeding

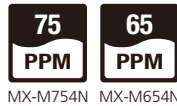

## Speedy Document Feeding



The MX-M754N/M654N comes standard with a highly efficient **150-sheet DSPF** (duplex single pass feeder), which **scans both pages** of two-sided documents up to A3 (11" x 17") in size in one pass. Doing away with the reversing circuit minimises paper misfeeds and vastly improves reliability. With a scanning speed of up to **100 opm\*** (one-sided) or **200 opm\*** (two-sided), the MX-M754N/M654N finishes even large projects quickly.

\* Originals per minute; when feeding A4 (8 1/2" x 11") sheets



## Extra Paper Capacity



For high-volume work, the MX-M754N/M654N can accommodate two types of optional large-capacity trays. One type is for A4 paper, for a total capacity of **6,700 sheets**.

The other is for paper ranging from B5 to A3 wide, for a total capacity of **6,200 sheets**. When a tray runs out of paper, the **Auto Tray Switching** function automatically switches to another paper tray filled with same-size paper, allowing you to do extra-large-volume jobs without worry.



## Versatile Paper Handling, In-Line Finishing Options



The MX-M754N/M654N can handle paper up to **300 g/m<sup>2</sup>\*1** thick as well as extra-long paper up to **1,200 mm\*2**, expanding the range of possible printing applications.

\*1: Paper thicker than 220 g/m<sup>2</sup> must be fed through multi-bypass tray.  
\*2: Requires optional MX-LT10.

The MX-M754N/M654N automates time-consuming finishing tasks and makes it easy to create professional-looking direct mail, handouts, booklets, brochures, and more.

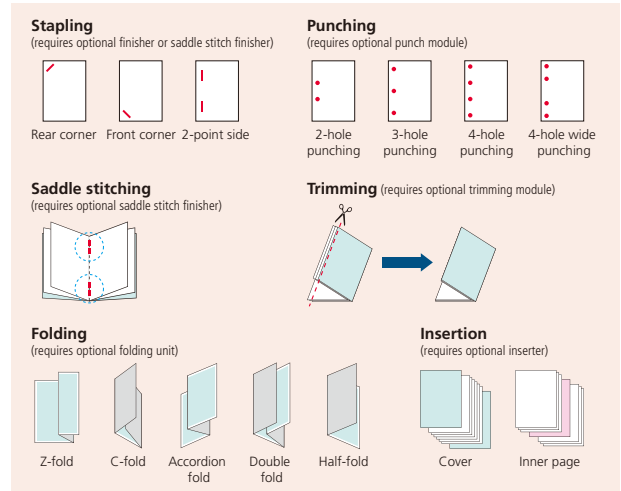

## Limitless Operation



There's no need to stop the MX-M754N/M654N during large-volume copy/print jobs when the toner cartridge needs changing or when a paper tray needs replenishing. This means minimum downtime for the MFP during busy workloads. The MX-M754N/M654N can use toner from the large **intermediate toner hopper** to continue printing while the empty toner cartridge is replaced with a new one. Paper trays not currently in use can also be replenished without stopping the machine.



Printing continues during toner cartridge replacement

# SUPERB IMAGE QUALITY

## High-Resolution Output



The MX-M754N/M654N delivers 600-dpi copying and razor-sharp **1,200-dpi** printing—without sacrificing output speed. Digital smoothing technology enhances the print and copy resolution to the equivalent of **9,600 x 600 dpi** for incredibly smooth reproduction of fine lines. Fine-grained photographs, detailed illustrations and graphs, and small text come out crisp and clear.

## Stable Halftones and Smooth Gradations



Halftone process control employs an image density sensor to enhance the stability and accuracy of halftones, thereby bringing consistently high image quality to copy/print jobs. Meanwhile, 4-bit depth, rated at 600 dpi resolution, generates fine dots and rich greyscales that provide smooth gradations.

## PCL 6 and True Adobe® PostScript® 3™



For improved graphics handling and enhanced font compatibility, the MX-M754N/M654N comes standard with both PCL 6 and true Adobe PostScript 3.

## Enhanced Scanning and Copying



- Scanning:** Through an advanced three-step process, **Auto Colour Mode** provides fully automated colour scanning. Here's how it works: Auto Colour Selection automatically determines whether a page is colour or B/W. Page contents are then analysed to distinguish between different components, such as photos and text, and the appropriate scan mode is selected. Finally, Background Suppression automatically removes unnecessary background colour.
- Copying:** Page-content analysis and background suppression also work when copying to deliver high-quality images.

## Curl Correction Unit

The optional Curl Correction Unit uses top and bottom rollers to smooth out sheets during paper travel. This keeps the paper from warping before it goes to the finisher and contributes to fast, stable paper feeding.

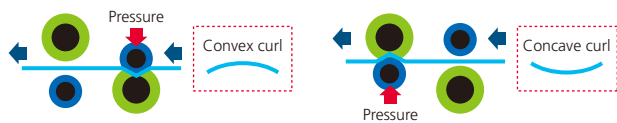

## Mirroring Kit

To protect the enhanced data handling capability of the MFP's hard disk, the optional Mirroring Kit offers hard disk backup and peace of mind.

## Extremely Sturdy Frame

The compact but extremely sturdy frame brings reliability and durability, ensuring that the MX-M754N/M654N can withstand heavy use from high-speed or high-volume output.



## Full Front Access

Particularly handy during toner cartridge replacement, an unlikely paper jam, and other operations, full front access to all key machine components ensures easy maintenance—and maximum uptime.

# EASE OF USE

## 10.1-Inch Colour LCD Touchscreen

MFP operation has never been so intuitive, so easy. The MX-M754N/M654N's control panel features a wide, clear, WSVGA-resolution LCD touchscreen. Simple gestures—flick, drag, tap, and more—performed on the screen bring easy control of every document, function, and setting. And dual-touch pinch and spread gestures enable smooth Web browsing and effortless shrinking/enlarging of Advanced Preview images. For strain-free viewing, the MFP's user interface employs a bold scalable font in sizes that vary in line with the content on display.

### Advanced Preview

The Advanced Preview function saves you time and effort by displaying scanned images on the LCD for confirmation and editing. Page layout and document finishes such as stapling can be checked before the documents are printed out. Previewed pages can be easily rotated, put in a different order, and deleted via tap-and-drag editing right on the LCD. You can even erase specific parts of a previewed page and insert blank pages.

#### Preview Mode

##### Thumbnail Preview



##### 3D Preview



#### Edit Mode

##### Page Rotation



##### Page Transfer



### Customisable Screen

The Home screen can be customised for individual users by programming their most frequently used functions and settings, creating **shortcut keys** for quick and easy access, and using logos, icons, background images, and other items prepared by the user. The **Enlarge Display** mode brings added readability.



### Action Panel

The Action Panel appears on the right side of the touchscreen to guide you through operational procedures. The MFP intuits what actions to take next and the Action Panel displays shortcut keys and messages pertaining to those actions.

### Mode Tabs

Mode tabs at the top of the screen make it easy to change job modes (copy, e-mail, document filing, Sharp OSA, etc.).



## Other User-Friendly Features

### Tiltable Control Panel

The control panel can be tilted at various angles for easy viewing and easy operation, even from a wheelchair.



### Retractable Keyboard (option)

A **full-size retractable QWERTY keyboard** slides out from beneath the control panel for fast and easy text input.



## INFORMATION SHARING

### Multiple Distribution of Scanned Files

You can choose different ways to distribute your scanned documents: for example, send as an e-mail attachment or scan directly to an FTP server for storage. The standard-equipped compact PDF function enables data to be transmitted and received smoothly.

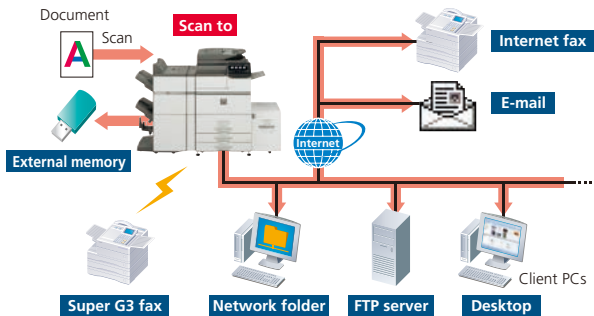

### Versatile Fax Functions (option)

- **Super G3 Fax** function
- **Internet Fax** lets you economically send and receive faxes to and from other T-37-compliant Internet fax machines via the Internet.
- **PC-Fax** lets you send documents created on a PC directly to a recipient's fax machine via a phone line without printing to paper.
- **Inbound Routing** can forward incoming faxes to another fax/Internet fax machine, an FTP server, a network folder (SMB), or a PC desktop before printing them out.

## MULTI-LAYERED SECURITY

### Network Security and Access Control

- **IP/MAC Address Filtering** prevents unauthorised access to networked MFPs by allowing access only to PCs that have a registered IP or MAC address.
- **User Authentication** covering up to 1,000 users prevents unauthorised MFP use by requiring access passwords.
- **SSL** (secure sockets layer) and **IPsec** data encryption technologies ensure secure network communications.

### Document Protection

- **Document Control\*** prevents unauthorised use of confidential documents by embedding copy prevention data onto them.  
\* Requires optional Data Security Kit. May not work with certain types of paper, documents (such as those with a large volume of photos), or MFP settings.
- **Hidden Pattern Copy/Print** embeds a watermark, such as "Confidential" or "Not for Copy," onto a document.
- **Tracking Information Print** prints the MFP user's name, the date, job ID, and other specifics on printouts, making it possible to track documents.

### Data Protection

- Job data is automatically **encrypted** before being saved to the MFP's internal storage. Once a job is finished, its encrypted data is **erased** by up to 10 automatic overwrites.  
Note: Contact a Sharp customer representative for details on activating this function.
- Retained data can be **initialised** when it's time to replace the MFP, preventing the leakage of confidential information.

### Handy Scan Functions

- **One Scan/Multi Format** lets users specify image resolution and colour for each mode of broadcasting employed. For example, you can send a B/W version via fax and a full-colour version via e-mail.
- **Auto File Division** lets you e-mail a large, multi-page data file that exceeds the file-transmission capacity. Simply set the MFP to automatically split that file into several separate files, which will then be e-mailed out individually.
- **Drop Out Colour** removes chromatic colour from a scanned image, enhancing the legibility of B/W text and reducing the data size for compact storage.

### Seamless Document Management

- With **Sharpdesk** integrated document management software, scanned files can be organised, edited, converted, and combined with ease, and Full Text Search can bring easy document retrieval.
- **Document Filing** allows processed data to be saved in designated folders on the MFP's hard disk, where they can be instantly recalled for printing and sending at a later time.
- The MFP's hard disk enables files created with applications such as Word and Excel® to be saved in their original format and shared across the office network.

## DEVICE MANAGEMENT

### Web-Based System Settings

Administrators can manage user access and security settings as well as other controls and configurations right from their desktops through a standard Web browser.

### Network Utility Software

**Sharp Remote Device Manager** (SRDM) gives administrators centralised control of their networked MFPs through a standard Web browser.

### Remote Operation

Working from an office-networked PC, users and/or administrators can remotely view the MFP's control panel and operate its features and functions.

## EXPANDABILITY

### Direct Internet Access

The optional **Web Browsing Expansion Kit** offers direct access to the Internet for easy browsing of Web sites on the colour touchscreen.

### Sharpdesk Mobile\*

Sharpdesk Mobile is a mobile print/scan application that connects the MFP to mobile devices via wireless LAN.

\* Availability varies by country/region. For details, see the Sharpdesk Mobile support Web site:  
[http://sharp-world.com/products/copier/docu\\_solutions/mobile/sharpdesk\\_mobile/](http://sharp-world.com/products/copier/docu_solutions/mobile/sharpdesk_mobile/)

### Sharp OSA\* (Open Systems Architecture)

Sharp OSA allows integration with cloud-based applications.

\* Requires optional MX-AMX2 and/or MX-AMX3.

## Low TEC Value

By pursuing technological excellence in all aspects of this MFP, including its hardware, software, and electrical system, Sharp has succeeded in developing a product with exceptional energy efficiency. A low-temperature belt fusing system and a short warm-up time of **20 seconds** reduce overall energy consumption. As a result, the MX-M754N/M654N boasts a TEC value\*<sup>1</sup> that is among the lowest in the industry—significantly lower than the maximum allowable values determined by ENERGY STAR.

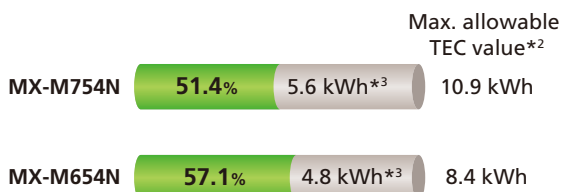

\*1: Typical amount of energy consumed in a hypothetical week measured as stipulated under the ENERGY STAR programme.

\*2: Maximum TEC value allowable under the latest ENERGY STAR programme (version 2.0). \*3: Measured at 230V.

## Other Outstanding Eco Technologies

- **Power ON/OFF Schedule** function automatically turns the MFP on or off per administrator-set schedules.
- Based on prior usage patterns, the MX-M754N/M654N automatically determines the optimal length of time to let elapse before going into **auto power shut-off mode**, helping reduce overall power consumption.
- **Eco Scan** function saves energy by keeping the fusing system shut down during jobs that don't require its use.
- **Eco Recommendation** function suggests environmentally friendly settings before a print\*/copy command is executed from the control panel.
  - \* For printing Document Filing data and direct printing (FTP/SMB/USB).
- Energy-efficient **LED lamps** employed in the scan unit (instead of conventional xenon lamps) provide further energy savings.

# SYSTEM CONFIGURATION

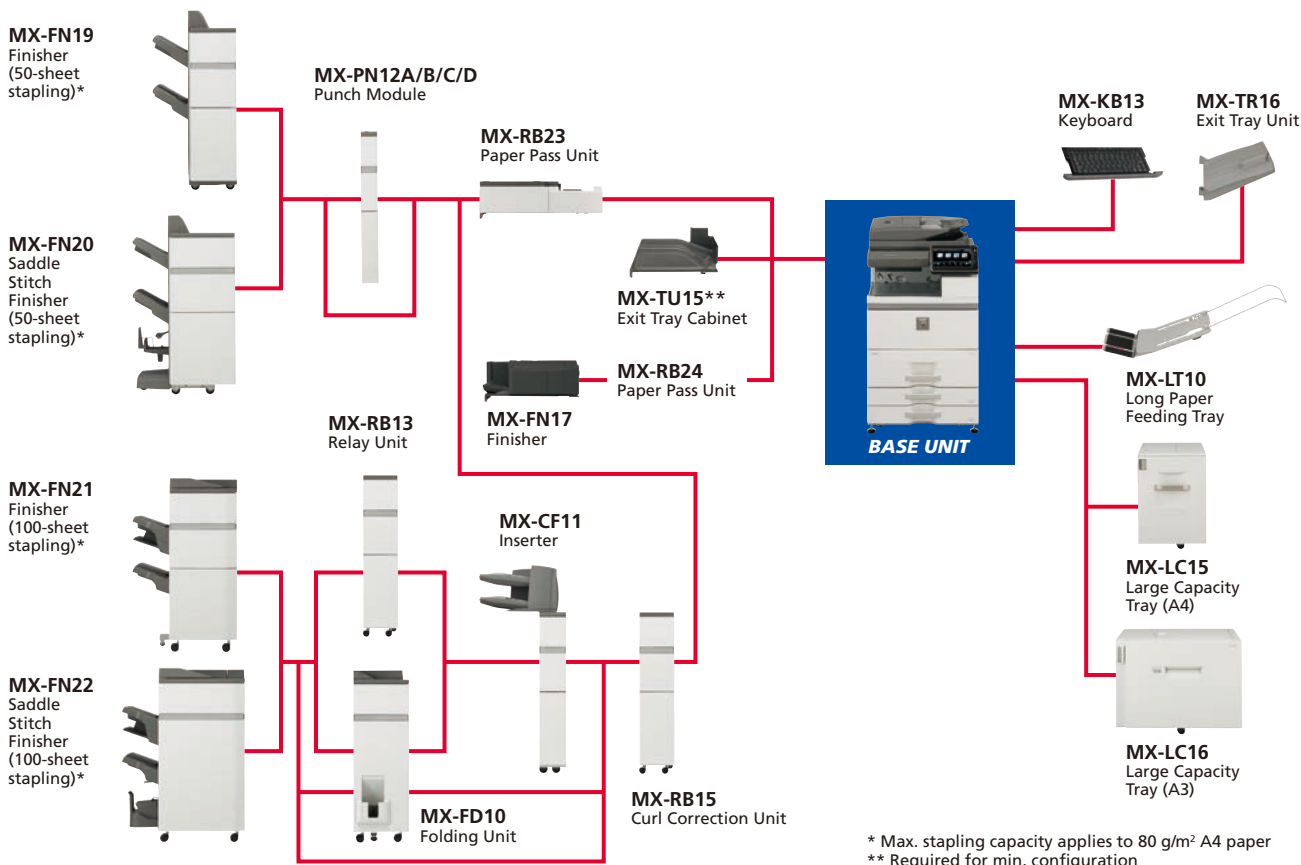

\* Max. stapling capacity applies to 80 g/m<sup>2</sup> A4 paper  
 \*\* Required for min. configuration

<b>MX-PN13A/B/C/D</b> Punch Module (for MX-FN21/FN22)	<b>MX-AM10</b> Web Browsing Expansion Kit	<b>MX-USX1/X5</b> Sharpdesk 1/5-License Kit	<b>MX-AMX3</b> External Account Module
<b>MX-TM10</b> Trimming Module (for MX-FN22)	<b>AR-SU1</b> Stamp Unit	<b>MX-US10/50/A0</b> Sharpdesk 10/50/100-License Kit	<b>MX-EB12 N</b> Mirroring Kit
<b>MX-PUX1</b> XPS Expansion Kit	<b>MX-FX11</b> Fax Expansion Kit	<b>MX-AMX1</b> Application Integration Module	<b>MX-FR47U</b> Data Security Kit
<b>MX-PF10</b> Barcode Font Kit	<b>MX-FWX1</b> Internet Fax Expansion Kit	<b>MX-AMX2</b> Application Communication Module	

Certain options may not be available in some areas.

## SPECIFICATIONS (tentative)

### General

Type	Console
Engine speed	A4 (8 1/2" x 11")*1: Max. 75/65 ppm A3 (11" x 17")*: Max. 37/34 ppm 10.1-inch colour LCD touchscreen
Control panel display	Max. A3 wide (12" x 18"), min. A5 (5 1/2" x 8 1/2")*2
Paper size	Standard: 3,200 sheets (2,100-sheet tray, 500-sheet tray x 2, and 100-sheet multi-bypass tray)
Paper capacity (80 g/m <sup>2</sup> )	Maximum: 6,700 sheets (3,200 sheets & optional 3,500-sheet tray)
Paper weight*3	Tray 1&2: 60 g/m <sup>2</sup> to 105 g/m <sup>2</sup> (16 lbs bond to 28 lbs bond) Tray 3&4: 60 g/m <sup>2</sup> to 220 g/m <sup>2</sup> (16 lbs bond to 80 lbs cover) Multi-bypass tray: 55 g/m <sup>2</sup> to 300 g/m <sup>2</sup> (13 lbs bond to 110 lbs cover) Large capacity tray (MX-LC15, MX-LC16): 60 g/m <sup>2</sup> to 220 g/m <sup>2</sup> (16 lbs bond to 80 lbs cover)
Warm-up time*4	20 sec.
Memory	Standard: 3GB (copy/print shared)      320GB HDD*5 Option: 1GB
Power requirements	Rated local AC voltage ±10%, 50/60 Hz
Power consumption	Max. 1.84 kW (220 to 240V), max. 1.92 kW (110 to 127V)
Dimensions (W x D x H)*6	663 x 772 x 1,218 mm (26 1/16" x 30 23/64" x 47 61/64")
Weight (approx.)	166 kg (365.9 lbs)

### Copier

Original paper size	Max. A3 (11" x 17")
First copy time*7	3.5/3.9 sec.
Continuous copy	Max. 9,999 copies
Resolution	Scan: 600 x 600 dpi, 600 x 400 dpi, 600 x 300 dpi*8 Print: 1,200 x 1,200 dpi, 600 x 600 dpi, 9,600 (equivalent) x 600 dpi
Gradation	Scan: 256 levels      Print: 256 levels (equivalent)
Zoom range	25% to 400% (25% to 200% using DSPF) in 1% increments
Preset copy ratios	Metric: 10 ratios (5R/5E), inch: 8 ratios (4R/4E)

### Network Colour Scanner

Scan method	Push scan (via control panel) Pull scan (TWAIN-compliant application)
Scan speed*9 (colour & B/W)	One-sided: Max. 100 originals/min. Two-sided: Max. 200 originals/min.
Resolution	Push scan: 100, 150, 200, 300, 400, 600 dpi Pull scan: 75, 100, 150, 200, 300, 400, 600 dpi 50 to 9,600 dpi via user setting
File formats	TIFF, PDF, PDF/A, encrypted PDF, compact PDF, JPEG*10, XPS
Scanner utility	Sharpdesk
Scan destinations	Scan to e-mail/desktop/FTP server/network folder (SMB)/ USB memory

- \*1: Long-edge feeding.
- \*2: Only short-edge feeding can be used with A5 (5 1/2" x 8 1/2") paper.
- \*3: Depending on usage conditions and type of paper, printing may not be executed correctly.
- \*4: At rated voltage, 23°C (73.4°F). May vary depending on operating conditions and environment.
- \*5: HDD capacity depends on procurement and sourcing status.
- \*6: Including adjusters and protuberances.
- \*7: Long-edge feeding of A4 (8 1/2" x 11") sheets from paper tray, using document glass, MFP in fully ready condition. May vary depending on operating conditions and environment.
- \*8: Only available when using DSPF.
- \*9: Based on Sharp's A4 standard chart, using document feeder and long-edge feeding. Using factory default settings with Auto Colour Selection off. Scan speed will vary depending on the type of document and the scan settings.
- \*10: Colour only.
- \*11: Storage capacity will vary depending on the type of document and the scan settings.
- \*12: Some features require option(s).
- \*13: IPv6 is supported only by LPR printing protocol.
- \*14: Requires optional MX-PUX1 and 1GB memory.
- \*15: Based on Sharp's standard chart with approx. 700 characters (A4 or 8 1/2" x 11" long-edge feeding) at standard resolution in Super G3 mode, 33,600 bps, JBIG compression.

### Document Filing

Document filing capacity*11	Main and custom folders: 20,000 pages or 3,000 files Quick file folder: 10,000 pages or 1,000 files
Stored jobs*12	Copy, print, scan, fax
Storage folders	Quick file folder, main folder, custom folder (max. 1,000 folders)
Confidential storage	Password protection

### Network Printer

Resolution	1,200 x 1,200 dpi, 600 x 600 dpi, 9,600 (equivalent) x 600 dpi
Interface	USB 2.0, 10Base-T/100Base-TX/1000Base-T
Supported OS	Windows Server® 2003, Windows Server® 2003 R2, Windows Server® 2008, Windows Server® 2008 R2, Windows Server® 2012, Windows Server® 2012 R2, Windows Vista®, Windows® 7, Windows® 8, Windows® 8.1, Mac OS X 10.4, 10.5, 10.6, 10.7, 10.8, 10.9, 10.10
Network protocols	TCP/IP (IPv4, IPv6), IPX/SPX (NetWare), EtherTalk (AppleTalk)
Printing protocols*13	LPR, Raw TCP (port 9100), POP3 (e-mail printing), HTTP, FTP for downloading print files, EtherTalk printing, IPP
PDL	Standard: PCL 6 emulation, Adobe® PostScript® 3™ Option: XPS*14
Available fonts	80 fonts for PCL, 139 fonts for Adobe PostScript 3

### Facsimile (optional MX-FX11 required)

Compression method	MH/MR/MMR/JBIG
Communication protocol	Super G3/G3
Transmission time	Less than 3 seconds*15
Modem speed	33,600 bps to 2,400 bps with automatic fallback
Transmission resolution	From Standard (203.2 x 97.8 dpi) to Ultra Fine (406.4 x 391 dpi)
Recording size	A3 to A5 (11" x 17" to 5 1/2" x 8 1/2")
Memory	1GB
Greyscale levels	Equivalent to 256 levels

- Design and specifications are subject to change without prior notice.
- PCL is a registered trademark of Hewlett-Packard Company. Adobe and PostScript 3 are either registered trademarks or trademarks of Adobe Systems Incorporated in the US and/or other countries. Windows, Windows Server, and Windows Vista are registered trademarks of Microsoft Corporation in the US and/or other countries. Mac OS, EtherTalk, and AppleTalk are trademarks of Apple Inc., registered in the US and other countries. All other brand names and product names may be trademarks or registered trademarks of their respective owners.
- The ENERGY STAR logo is a certification mark and may only be used to certify products that have been determined to meet the ENERGY STAR programme requirements. ENERGY STAR and the ENERGY STAR mark are registered trademarks owned by the US Environmental Protection Agency. The ENERGY STAR guidelines apply to products only in the US, the EU, Japan, Canada, Australia, New Zealand, and Taiwan.

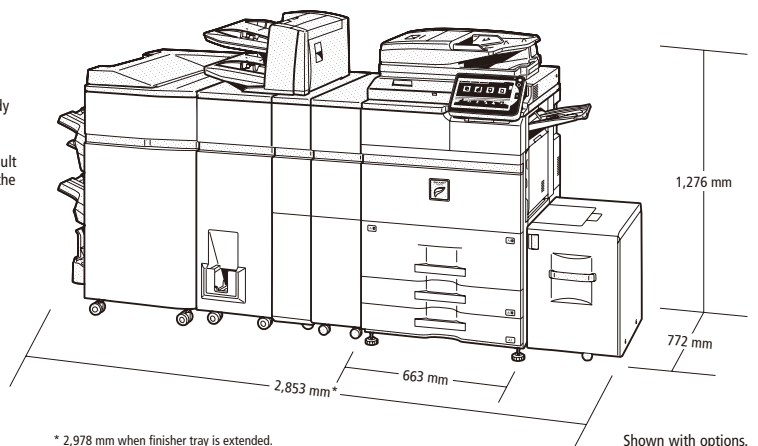

Distributed by:

# SHARP